

# PRESSURE GAUGES

# PG-20



## FEATURES

- External diameter  $\phi$  20mm. Easily installable fitting block
- Rotable display part (90°step, 270° full travel)
- Wide combination of output types (switch, current or voltage) available
- Integrally welded structure of sensing chip and fitting block

## INTERNAL STRUCTURE (R 1/4)

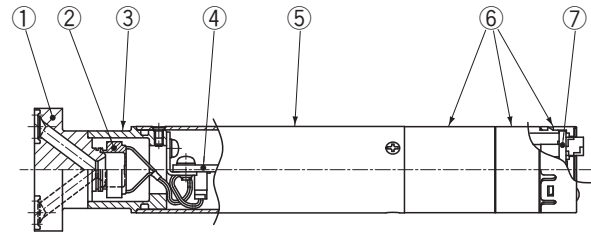

Part name		Material
①	Fitting block	SUS316L of Double melt
②	Sensor module	SUS316L of Double melt
③	Sensor holder	SUS316L
④	Amp board	—
⑤	Cover	SUS316L
⑥	Case	PBT
⑦	Display board	—

## MODEL NUMBER DESIGNATION

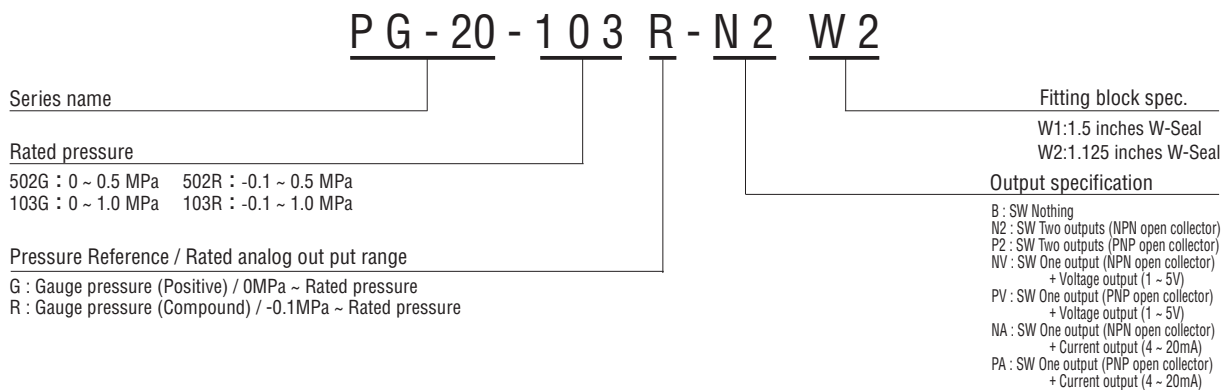

## LIST OF MODEL NUMBERS

Output specification		Rated Pressure	
Switch output	Analog output	502	103
None	None	PG-20-502R-BW*	PG-20-103R-BW*
Two outputs		PG-20-502R-N2W*	PG-20-103R-N2W*
One outputs	Voltage output	PG-20-502R-P2W*	PG-20-103R-P2W*
		PG-20-502□-NVW*	PG-20-103□-NVW*
	Current output	PG-20-502□-PVW*	PG-20-103□-PVW*
		PG-20-502□-NAW*	PG-20-103□-NAW*
		PG-20-502□-PAW*	PG-20-103□-PAW*

Note 1. W\* : Fitting block spec. (W1/W2)  
 Note 2. □ : G (Positive) / R (Compound)

### STANDARD SPECIFICATIONS

Item		Model number	PG-20	
			502	103
General specifications	Pressure reference		Gauge	
	Rated pressure range	Positive (G)	0 ~ 0.5 MPa	0 ~ 1.0 MPa
		Compound (R)	- 0.1 ~ 0.5 MPa	- 0.1 ~ 1.0 MPa
	Maximum pressure		0.75 MPa	1.5 MPa
	Vacuum pressure		1.4 × 10 <sup>-4</sup> Pa abs (minimum)	
	Leakage (He vacuum method)		5 × 10 <sup>-12</sup> Pa·m <sup>3</sup> / sec. minimum (Weld in pressure port)	
	Operating temp.range		- 10 ~ 50°C(No condensation)	
	Compensated temp. range		0 ~ 50°C	
	Operating humidity range		35 ~ 85% RH (No condensation)	
	Storage temp. range		- 20 ~ 60°C(Atmospheric pressure, humidity 65%RH minimum)	
	Media		Gases and Liquids compatible with SUS316L	
	Insulation resistance		50MΩ minimum (Between bundled electrical wirings and the pressure port. at 125VDC)	
	Pressure contact material		SUS316L Double-Melt Material (Fitting and Sensor)	
	Pressure contact roughness		(Ra : 0.15, Rz : 0.7) μm minimum	
	Pressure contact particle		Zero count of particle of the size 0.1m μm or bigger (By our inspection standard)	
	Cable connector		Cable length : 2m cable AWG26 / include cable holder	
	Protection grade		IP40	
Net weight		Approx. 200g (W1) Approx. 110g (W2)		
Voltage	Operating voltage		Voltage output type and other : 12~24VDC±10% (including ripple) Current output type : 24VDC±10%(including ripple)	
	Current consumption		30mA minimum (No current flow from switch / analog output)	
	CE marking		EN61326-1 : 2006, EN61326-2-3 : 2006 EMI : Class B, EMS : Annex BB	
	Display Method		3 -1/2 LED display ( Red LED)	
Pressure Display	Rotation angle		270°(90° step)	
	Rated display range	Positive (G)	.000 ~ .500 MPa	.000 ~ 1.000 MPa
		Compound (R)	- .100 ~ .500 MPa	- .100 ~ 1.000 MPa
	Display cycle		4 times / sec	
	Display accuracy		± 1.0% FS (The repeatability, linearity and hysteresis are contained)	
	Thermal error		± 0.1% FS / °C ( 0 ~ 50°C Reference temp. 25°C )	
	Resolution		1 digit	
	Over range		**** Blinking of pressure display (110 % F.S.or more)	
Additional function		Zero point adjustment, Panel lock		
Analog output	Output voltage		1 ~ 5 VDC(Output current : 1 mA minimum / Output resistance: 1.5 kΩ)	
	Output accuracy	Output accuracy	± 1.0% FS (The setting error and LIN / HYS are contained)	
		Temperature character	± 0.1% FS / °C ( 0 ~ 50°C Reference temp. 25°C )	
	Output current		4 ~ 20mA (Vort: 24VDC ±10% / 500Ω minimum)	
Output accuracy	Output accuracy	± 1.0% FS (The setting error and LIN / HYS are contained)		
	Temperature character	± 0.1% FS / °C ( 0 ~ 50°C Reference temp. 25°C )		
Switch output	Number of output		Output 1 or 2	
	Output interface		NPN / PNP transistor open collector	
	Switching capacity		30VDC 100mA minimum	
	Residual voltage		1.2V(NPN) / 2.2V(PNP) minimum (Load current 100mA)	
	Output working chart		Separate mode / Window comparator mode	
	Repeatability		± 0.3% FS minimum	
	Thermal error		± 0.1% FS / °C ( 0 ~ 50°C Reference temp. 25°C )	
	Response		Approx. 2.5, 25, 250 ms	
Hysteresis setting		0 ~ 300counts (Select panel SW)		

# PG-20 PRESSURE GAUGES

## INTERNAL ELECTRICAL SCHEMATICS

● PG-20-\*\*\*\*-N2\*\*

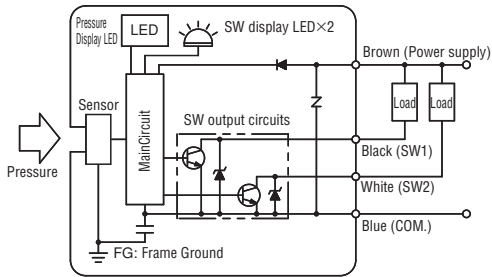

● PG-20-\*\*\*\*-P2\*\*

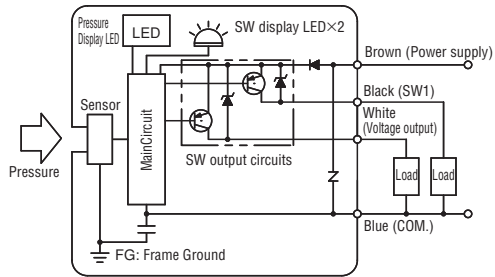

● PG-20-\*\*\*\*-NV\*\*

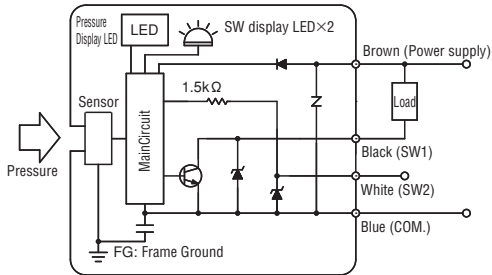

● PG-20-\*\*\*\*-PV\*\*

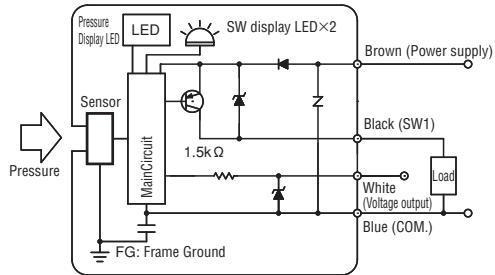

● PG-20-\*\*\*\*-NA\*\*

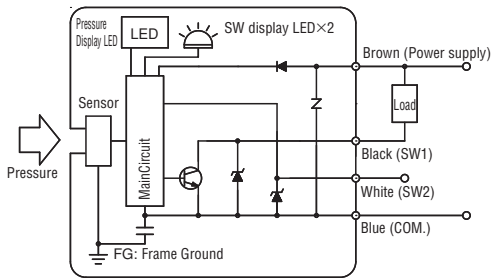

● PG-20-\*\*\*\*-PV\*\*

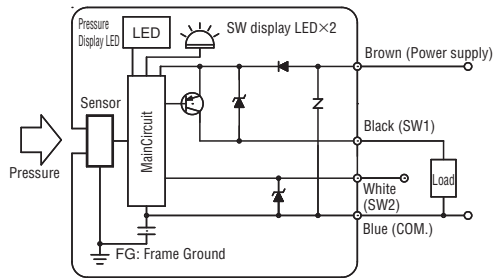

Model number	PG-20-****			
color	-BW*	-N2W* / -P2W*	-NVW* / -PVW*	-NAW* / -PAW*
Brown	(12~24 V D C ±10%)			(24VDC±10%)
Black	N.C.	SW1 (NPN/PNP)		
White	N.C.	SW2 (NPN/PNP)	(1-5V)	(4-20mA)
Blue	COMMON			

## OUTLINE DIMENSIONS

Unless otherwise specified tolerance : ± 0.5 (Unit: mm)

### PG-20-\*\*\*R/G-\*\*\*W1

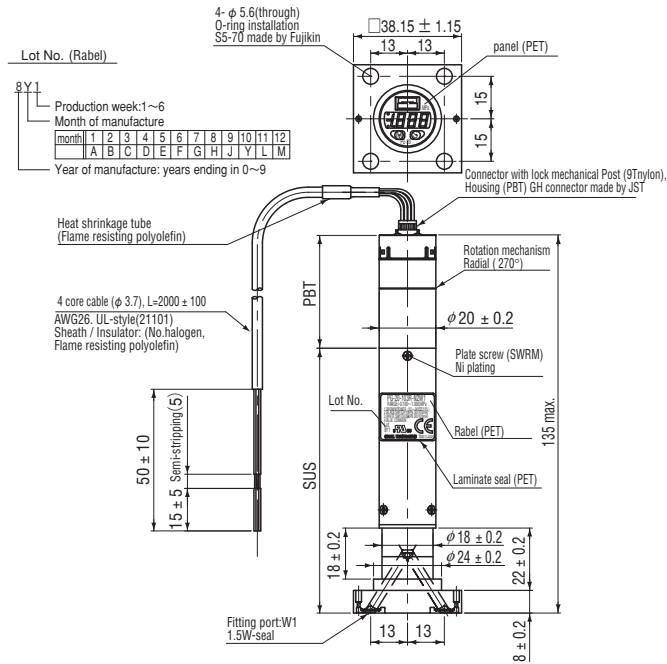

### PG-20-\*\*\*R/G-\*\*\*W2

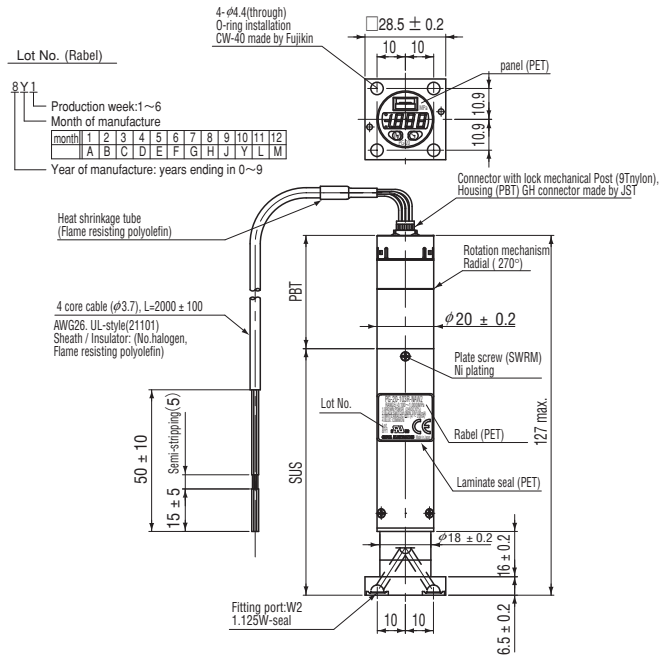

## SWITCH OUTPUT MODE

Output	SW1				SW2			
	Separate		Window comparator		Separate		Window comparator	
Mode	HI	LO	A	B	HI	LO	A	B
Operation								
S-1	○				○			
S-2	○				○	○		
S-3		○				○		
S-4		○				○		
C-5			○				○	
C-6			○				○	○
C-7				○				○
C-8				○				○
Pressure setting (Operating point)	Setting 1		(Lower limit) : Setting 1 (Upper limit) : Setting 2		Setting 2		(Lower limit) : Setting 1 (Upper limit) : Setting 2	

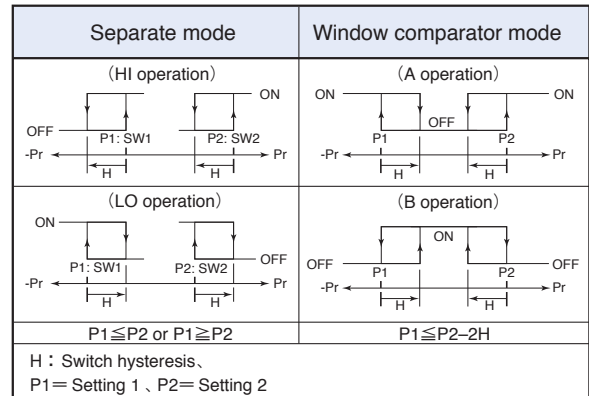

Note 1. In the Separate Mode, setting 1 corresponds to SW1, and Setting 2 corresponds to SW2.

Note 2. In the Window Comparator Mode, the minimum value for SW1 and SW2 corresponds to Setting 1 and the maximum value corresponds to Setting 2.

Note 3. It becomes only "SW1" for one switch output specification. In that case, it displays it in the switch operation mode in order of "S-1" "S-3" "C-5" "C-7".